

**studio** **XPS**<sup>™</sup>

**SETUP GUIDE**



**YOURS IS HERE**



# studio<sub>XPS</sub><sup>™</sup>

## SETUP GUIDE

Model PP17S

## Notes, Notices, and Cautions



**NOTE:** A NOTE indicates important information that helps you make better use of your computer.



**NOTICE:** A NOTICE indicates either potential damage to hardware or loss of data and tells you how to avoid the problem.



**CAUTION:** A CAUTION indicates a potential for property damage, personal injury, or death.

---

**Information in this document is subject to change without notice.**

**© 2008-2009 Dell Inc. All rights reserved.**

Reproduction of these materials in any manner whatsoever without the written permission of Dell Inc. is strictly forbidden.

Trademarks used in this text: *Dell*, the *DELL* logo, *XPS*, and *DellConnect* are trademarks of Dell Inc.; *Intel* is a registered trademark and *Core* is a trademark of Intel Corporation in the United States and other countries; *Microsoft*, *Windows*, *Windows Vista* and *Windows Vista start button logo* are either trademarks or registered trademarks of Microsoft Corporation in the United States and/or other countries.; *Blu-ray Disc* is a trademark of the Blu-ray Disc Association; *Bluetooth* is a registered trademark owned by Bluetooth SIG, Inc. and is used by Dell under license.

Other trademarks and trade names may be used in this document to refer to either the entities claiming the marks and names or their products. Dell Inc. disclaims any proprietary interest in trademarks and trade names other than its own.

# Contents

<b>Setting Up Your Studio XPS™ Laptop</b> . . . . .	<b>5</b>	Media, Wireless, and Power Controls . . . . .	<b>23</b>
Before Setting Up Your Computer . . . . .	5	Computer Base and Keyboard Features . . . . .	24
Connect the AC adapter . . . . .	6	Optional Graphics Processor Feature . . . . .	26
Check the Wireless Control . . . . .	7	Software Features . . . . .	26
Connect the Network Cable (Optional) . . . . .	8	<b>Solving Problems</b> . . . . .	<b>29</b>
Press the Power Control . . . . .	9	Network Problems . . . . .	29
Set Up Windows Vista® . . . . .	10	Power Problems . . . . .	30
Connecting to the Internet (Optional) . . . . .	10	Memory Problems . . . . .	31
Setting Up 5.1 Audio Connections . . . . .	12	Lockups and Software Problems . . . . .	31
Removing and Replacing the Battery . . . . .	13	<b>Using Support Tools</b> . . . . .	<b>33</b>
<b>Using Your Studio XPS™</b> . . . . .	<b>14</b>	Dell Support Center . . . . .	33
Device Status Lights . . . . .	14	System Messages . . . . .	34
Right Side Features . . . . .	16		
Left Side Features . . . . .	20		
Display Features . . . . .	22		

Hardware Troubleshooter . . . . .	35	<b>Finding More Information and Resources . . . . .</b>	<b>48</b>
Dell Diagnostics . . . . .	36	<b>Basic Specifications . . . . .</b>	<b>50</b>
<b>System Restore Options . . . . .</b>	<b>37</b>	<b>Index . . . . .</b>	<b>59</b>
System Restore . . . . .	37		
Dell Factory Image Restore . . . . .	38		
Operating System Reinstallation . . . . .	40		
<b>Getting Help . . . . .</b>	<b>42</b>		
Technical Support and Customer Service . . . . .	43		
DellConnect™ . . . . .	43		
Online Services . . . . .	43		
AutoTech Service. . . . .	44		
Product Information. . . . .	45		
Returning Items for Repair Under Warranty or for Credit. . . . .	45		
Before You Call. . . . .	46		
Contacting Dell. . . . .	47		

# Setting Up Your Studio XPS™ Laptop

This section provides information to help you set up your Studio XPS 1340 and connect the peripherals.

## Before Setting Up Your Computer

When positioning your computer, ensure that you have easy access to a power source, adequate ventilation, and a level surface to place your computer.

Restricting airflow around your computer may cause it to overheat. To prevent overheating ensure that you leave at least 10.2 cm (4 in) at the back of the computer and a minimum of 5.1 cm (2 in) on all other sides. You should never place your computer in an enclosed space, such as a cabinet or drawer when it is turned on.

- ➡ **NOTICE:** Placing or stacking heavy or sharp objects on the computer may result in permanent damage to the computer.



### Connect the AC adapter

Connect the AC adapter to the computer and then plug it into a wall outlet or surge protector.



**CAUTION:** The AC adapter works with worldwide power outlets. However, power connectors and power strips vary among countries. Using an incompatible cable or incorrectly connecting the cable to a power strip or electrical outlet may cause fire or equipment damage.





### Check the Wireless Control

To turn on wireless, with the computer turned on, gently touch the wireless control  on the center control cover and then release.

This control allows you to quickly turn off all your wireless radios (Bluetooth®, WiFi, and WWAN), such as when you are asked to disable all wireless radios on an airplane flight. Gently touching this control once turns off all wireless radios. Gently touching this control again returns your wireless radios to their respective states they were in before you turned them off.



## Connect the Network Cable (Optional)

To use a wired network connection, connect the network cable.



## Press the Power Control



### Set Up Windows Vista®

Your computer is pre-configured with Windows Vista. To set up Windows Vista for the first time, follow the instructions on the screen. These steps are mandatory and may take up to 15 minutes to complete. The screens will take you through several procedures including accepting license agreements, setting preferences, and setting up an Internet connection.

➔ **NOTICE:** Do not interrupt the operating system's setup process. Doing so may render your computer unusable.

### Connecting to the Internet (Optional)

✎ **NOTE:** Internet Service Providers (ISPs) and ISP offerings vary by country.

To connect to the Internet, you need a network connection or an external modem and an ISP.

✎ **NOTE:** If an external USB modem is not a part of your original order, you can purchase one from the Dell website at [www.dell.com](http://www.dell.com).

#### Setting Up a Wired Internet Connection

If you are using a dial-up connection, connect the telephone line to the external USB modem (optional) and to the telephone wall connector before you set up your Internet connection.

If you are using a DSL or cable/satellite modem connection, contact your ISP or cellular telephone service for setup instructions and see "Setting Up Your Internet Connection" on page 11.

### Setting Up a Wireless Connection

See the documentation for your router for more information about how to set up and use your wireless network.

Before you can use your wireless Internet connection, you need to connect to your wireless router.

To establish connection using a wireless router:

1. Save and close any open files, and exit any open programs.
2. Click **Start**  → **Connect To**.
3. Follow the instructions on the screen to complete the setup.

### Setting Up Your Internet Connection

To set up an Internet connection with a provided ISP desktop shortcut:

1. Save and close any open files, and exit any open programs.
2. Double-click the ISP icon on the Microsoft® Windows® desktop.

3. Follow the instructions on the screen to complete the setup.

If you do not have an ISP icon on your desktop or if you want to set up an Internet connection with a different ISP, perform the steps in the following section.

 **NOTE:** If you cannot connect to the Internet but have successfully connected in the past, the ISP might have a service outage. Contact your ISP to check the service status, or try connecting again later.

 **NOTE:** Have your ISP information ready. If you do not have an ISP, the **Connect to the Internet** wizard can help you get one.

1. Save and close any open files, and exit any open programs.
2. Click **Start**  → **Control Panel**.
3. Under **Network and Internet**, click **Connect to the Internet**.

The **Connect to the Internet** window appears.

## Setting Up Your Studio XPS™ Laptop

4. Select either **Broadband (PPPoE)** or **Dial-up**, depending on how you want to connect:
    - a. Choose **Broadband** if you will use a DSL, satellite modem, cable TV modem, or wireless technology connection.
    - b. Choose **Dial-up** if you will use an optional USB dial-up modem or ISDN.
-  **NOTE:** If you do not know which type of connection to select, contact your ISP.
5. Follow the instructions on the screen and use the setup information provided by your ISP to complete the setup.

## Setting Up 5.1 Audio Connections

To set up 5.1 audio connections:

Click **Start**  → **Control Panel** → **Additional Options**. Run **IDT Audio Control Panel**. In the **Jacks** tab, there are three connector icons. Follow the instructions to finish the setup.

1. Click the microphone icon, select **Device: Rear Speakers**, and plug your rear speaker cable to the audio in/microphone connector.
2. Click the middle headphone icon, select **Device: Center/LFE Speaker**, and plug your center/woofer speaker cable to the middle audio out/headphone connector.
3. Click the right headphone icon, select **Device: Front Speaker**, and plug your front speaker cable to the right audio out/headphone connector.

## Removing and Replacing the Battery

**⚠ CAUTION:** Using an incompatible battery may increase the risk of fire or explosion. This computer should only use a battery purchased from Dell. Do not use batteries from other computers.

**⚠ CAUTION:** Before removing the battery, shut down the computer, and remove external cables (including the AC adapter).

To remove the battery:

1. Shut down the computer and turn it over.
2. Slide the battery release latch to the unlock position.
3. Slide the battery out.

To replace the battery, slide the battery into the bay until the battery clicks into place.

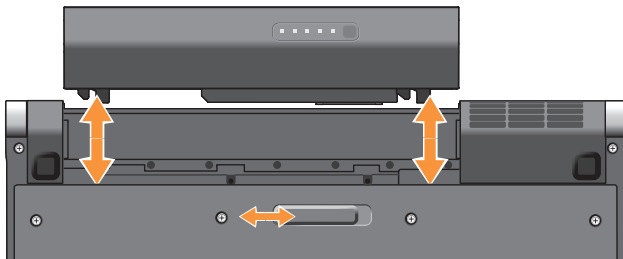

# Using Your Studio XPS™

Your computer has several indicators, controls, buttons, and features that provide information at-a-glance and time-saving shortcuts for common tasks.

## Device Status Lights









- 1  **Hard drive activity light** – Turns on when the computer reads or writes data. A flashing light indicates hard drive activity.

 **NOTICE:** To avoid loss of data, never turn off the computer while the hard drive activity light is flashing.

- 2  **Bluetooth® status light (optional)** – Turns on when a card with Bluetooth wireless technology is enabled.



 **NOTE:** The card with Bluetooth wireless technology is an optional feature.

You may turn off the Bluetooth wireless function by either gently touching the wireless control  or by right-clicking the Bluetooth icon in the notification area of your taskbar and clicking **Disable Bluetooth radio**.

- 3  **WiFi status light** – Turns on when wireless networking is enabled.  
Use the wireless control to quickly turn all wireless communication On or Off.
- 4  **WWAN status light** – Turns on when WWAN is enabled.

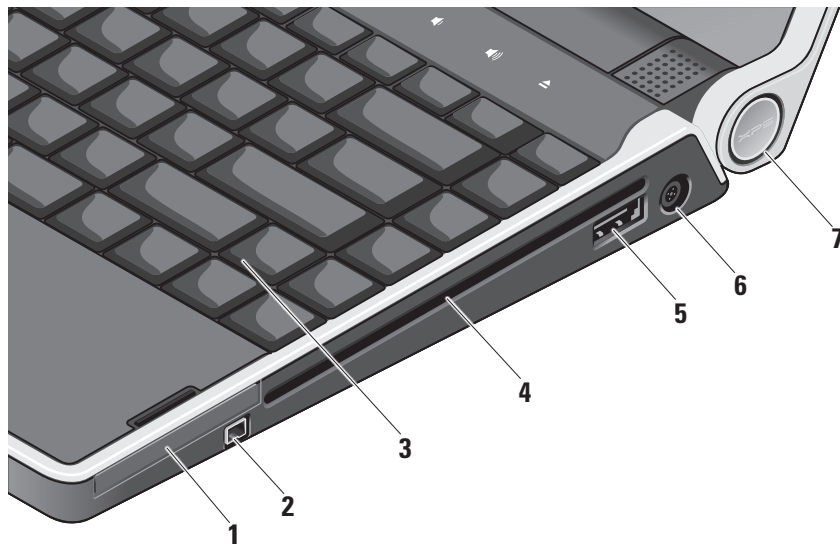
## Right Side Features





- 1  **ExpressCard slot** – Supports one ExpressCard.
- 2  **IEEE 1394 connector** – Connects to high-speed serial multimedia devices, such as digital video cameras.
- 3 **Backlit keyboard** – Provides visibility in dark environments by illuminating characters on all the keys. For more information see the *Dell Technology Guide*.

- 4 **Optical drive** – Can either play, read, or write to standard-size and shape (12 cm) CDs, and DVDs. Ensure that the side with print or writing is facing upward when inserting discs.

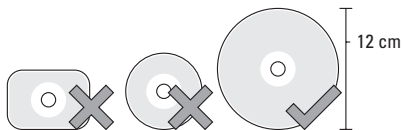
 **NOTICE:** Do not use non-standard-size or shape discs (including mini-CDs and mini-DVDs) as you will damage the drive.



- 5**  **eSATA/USB combo connector with PowerShare** – Connects to eSATA compatible storage devices (such as external hard-disk drives or optical drives) or USB devices (such as a mouse, keyboard, printer, external drive, or MP3 player). This connector can also be used for charging USB devices when the computer is in power on/off or sleep state. This function may not work with certain external devices when the computer is in power off or sleep state, even if they are compliant with the USB specification. In such cases, turn the computer on to charge the device.

 **NOTE:** If the computer is powered off or turned to sleep state while the USB device is charging, unplug the USB device and plug it in again to continue charging the device.

 **NOTE:** The USB PowerShare automatically shuts off when only 10% of the total battery life remains.

- 6**  **AC adapter connector** – Connects to the AC adapter which powers the computer and charges the battery.

- 7** **Power light** – Illuminates when the computer is powered on. The different lights indicate the following:

*On battery power:*

- Solid white – computer is running on battery power
- Solid amber – battery is low
- Flashing amber – battery is critically low
- Blinking white – computer is in sleep state

*On AC adapter:*

- Solid white – computer is powered on and battery is charged
- Blinking white – computer is in standby state.

## Using the Optical Disc Drive

➡ **NOTICE:** Do not use non-standard-size or shape discs (including mini-CDs and mini-DVDs) as you will damage the drive.

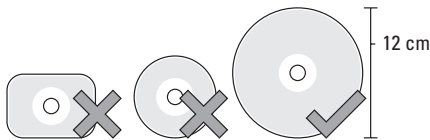

✍ **NOTE:** Do not move the computer while playing or recording CDs and DVDs.

Place the disc in the center of the disc slot, with the label facing upwards and gently push the disc into the slot. The drive will automatically pull the disc in and begin reading its content.



To eject a disc from the drive, gently touch the eject control . The control will flash to confirm for a few seconds before ejecting the disc.

## Left Side Features

 **NOTE:** Do not connect devices to the DisplayPort connector and HDMI connector at the same time.

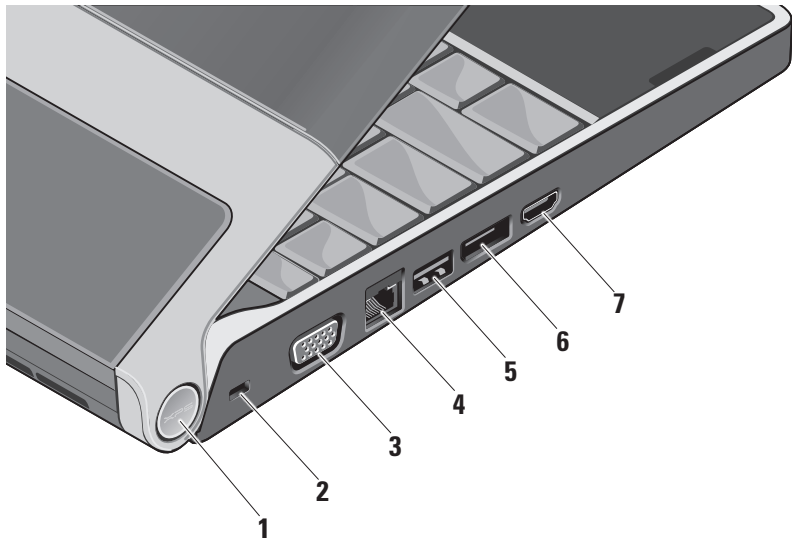

- 1 Power light** – Illuminates when the computer is powered on. The different lights indicate the following:

*On battery power:*

- Solid white – computer is running on battery power
- Solid amber – battery is low
- Flashing amber – battery is critically low
- Blinking white – computer in in sleep state

*On AC adapter:*

- Solid white – computer is powered on and battery is charged
- Blinking white – computer is in standby state

- 2 Security cable slot** – Attaches a commercially available antitheft device to the computer.

 **NOTE:** Before you buy an antitheft device, ensure that it works with the security cable slot.

- 3**  **VGA connector** – Connects to a monitor or projector.

- 4**  **Network connector** – Connects your computer to a network or broadband device if you are using a cabled network signal.

- 5**  **USB connector** – Connects USB devices, such as a mouse, keyboard, printer, external drive, or MP3 player.

- 6**  **DisplayPort connector** – Digital interface standard connector that supports an external DisplayPort monitor.

- 7**  **HDMI connector** – Connects to a TV for both 5.1 audio and video signals. This connector cannot be used as an input port for HDMI.

 **NOTE:** When used with a monitor, only the video signal is read.

## Display Features

The display panel holds a camera and accompanying dual digital array microphones.

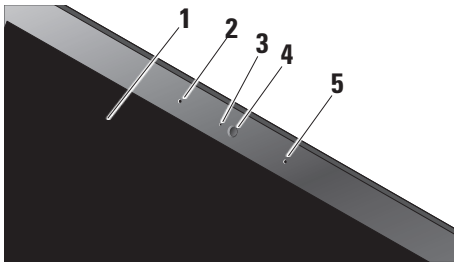

- 1 Display** – Your display can vary based on the selection you made when purchasing your computer. For more information about displays, see the *Dell Technology Guide*.
- 2 Left digital-array microphone** – Combines with the right digital-array microphone to provide high quality sound for video conferencing and voice recording.











- 3 Camera activity indicator** – Light that indicates when the camera is on and off.
- 4 Camera** – Built-in camera for video capture, conferencing, and chat. The camera utilizes advanced facial recognition software to keep your computer secure. This software learns your face and recognizes each time you login to your computer minimizing the need to manually login using passwords. For more information, click **Start**  → **Programs** → **FastAccess Facial Recognition**.
- 5 Right digital-array microphone** – Combines with the left digital-array microphone to provide high quality sound for video conferencing and voice recording.



## Media, Wireless, and Power Controls

To use the media, wireless, and power controls, gently touch the icon and then release. The control's icon lights up for 2 seconds to confirm your selection and then fades away.



- |   |  |   |                                |
|---|--|---|--------------------------------|
|  | Turn on power, or wake up from sleep state |  | Play the next track or chapter |
|  | Turn on/off wireless                       |  | Mute the volume                |
|  | Play the previous track or chapter         |  | Turn down the volume           |
|  | Stop                                       |  | Turn up the volume             |
|  | Play or pause                              |  | Eject the disc                 |

## Computer Base and Keyboard Features

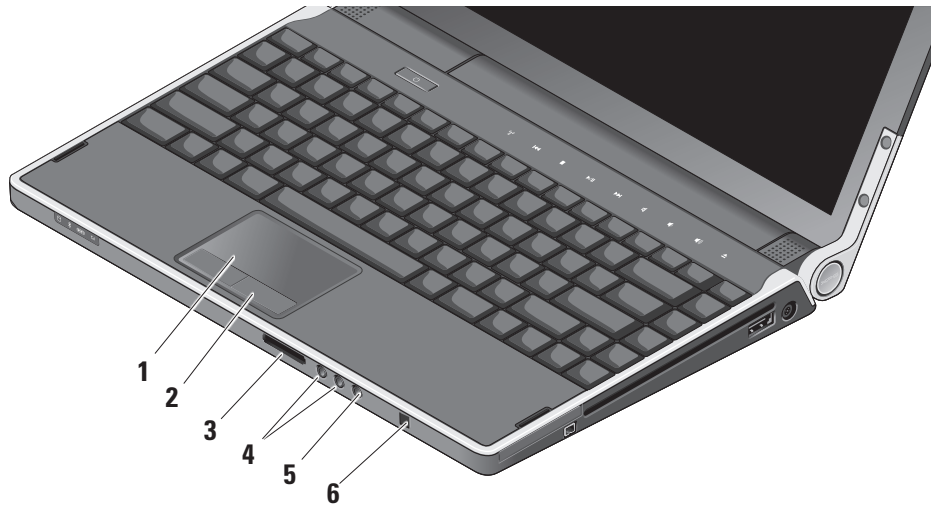

- 1 Touch pad** – Provides the functionality of a mouse to move the cursor, drag or move selected items, and left-click by tapping the surface. It supports circular scrolling and zoom.
- 2 Touch pad buttons (2)** – Provide left-click and right-click functions like those on a mouse.

**3** SD/MMC - MS/Pro - xD

**8-in-1 Media Card Reader** – Provides a fast and convenient way to view and share digital photos, music, videos, and documents stored on the following digital memory cards:

- Secure Digital (SD) memory card
- Secure Digital Input Output (SDIO) card
- Multi Media Card (MMC)
- Memory Stick
- Memory Stick PRO
- xD-Picture Card
- Hi Speed-SD
- Hi Density-SD

- 4**  **Audio out/headphone connectors (2)** – Connects one or two pairs of headphones, or sends audio to a powered speaker or sound system. The audio signal is the same for both connectors.

- 5**  **Audio in/microphone connector** – Connects to a microphone or input signal for use with audio programs.

- 6 Consumer IR** – Infrared sensor for using the optional Dell Travel Remote.

**Backlit Keyboard/Touch Pad Brightness Settings** – Press <Fn><→> keys to toggle between the three lighting states (in the given order).

The three lighting states are:

- full keyboard/touch pad brightness
- no lighting
- half keyboard/touch pad brightness

### **Touchpad Circular Scrolling and Zoom Settings**

To change the circular scrolling and zoom settings, double-click the Dell Touchpad icon on the right side of the taskbar.

In the Scrolling tab, you can enable or disable scrolling or circular scrolling, choose the scroll zone width, and scroll speed.

In the Gestures tab, you can enable or disable one finger zoom (zoom in and out moving the finger upward or downward) or the pinch zoom (zoom in and out by spreading two fingers or by bringing two fingers together).

## **Optional Graphics Processor Feature**

Your computer features the revolutionary Hybrid SLI technology. Hybrid SLI allows the central processor and graphics processor to work together and boost graphical performance.

### **Software Features**

 **NOTE:** For more information about the features described in this section, see the *Dell Technology Guide* on your hard drive or on the Dell Support website at [support.dell.com](http://support.dell.com).

### **Productivity and Communication**

You can use your computer to create presentations, brochures, greeting cards, fliers, and spreadsheets. You can also edit and view digital photographs and images. Check your purchase order for software installed on your computer.

After connecting to the Internet, you can access websites, setup an e-mail account, upload and download files, and so on.

### Entertainment and Multimedia

You can use your computer to watch videos, play games, create your own CDs/DVDs, listen to music and internet radio stations. Your optical disc drive may support multiple disc media formats including CDs and DVDs.

You can download or copy pictures and video files from portable devices, such as digital cameras and cell phones. Optional software applications enable you to organize and create music and video files that can be recorded to a disc, saved on portable products such as MP3 players and handheld entertainment devices, or played and viewed directly on connected TVs, projectors, and home theater equipment.

### Customizing the Desktop

You can customize your desktop to change the appearance, resolution, wallpaper, screensaver, and so on by accessing the **Personalize appearance and sounds** window.

To access the display properties window:

1. Right-click an open area of the desktop.
2. Click **Personalize**, to open the **Personalize appearance and sounds** window and learn more about your customization options.

### Customizing Your Energy Settings

You can use the power options in your operating system to configure the power settings on your computer. Microsoft® Windows Vista® provides three default options:

- **Balanced** — This power option offers full performance when you need it and saves power during periods of inactivity.

- **Power saver** — This power option saves power on your computer by reducing system performance to maximize the battery life and by reducing the amount of energy consumed by your computer over its lifetime.
- **High performance** — This power option provides the highest level of system performance on your computer by adapting processor speed to your activity and by maximizing system performance.

### Backing Up Your Data

It is recommended that you periodically back up files and folders on your computer. To back up files:

1. Click **Start**  → **Control Panel** → **System and Maintenance** → **Welcome Center** → **Transfer files and settings**.
2. Click **Back up files** or **Back up computer**.
3. Click **Continue on Your User Account Control** dialog box and follow the instructions in the **Back up Files** wizard.

# Solving Problems

This section provides troubleshooting information for your computer. If you cannot solve your problem using the following guidelines, see “Using Support Tools” on page 33 or “Contacting Dell” on page 47.

 **CAUTION:** Only trained service personnel should remove the computer cover. See the *Service Manual* on the Dell Support website at [support.dell.com](http://support.dell.com) for advanced service and troubleshooting instructions.

## Network Problems

### Wireless Connections

#### If the wireless network connection is lost

- The wireless control may have been unintentionally touched, deactivating your wireless radios. To turn on wireless again, with the computer turned on, gently touch the wireless control  on the center

control cover and then release. You can manage the Wireless LAN using *Intel PROSet* from your taskbar. You can also use *Windows Wireless Network Connections*, accessed from the Control Panel, to manage Wireless LAN.

- Interference may be blocking or interrupting your wireless connection. Try moving the computer closer to your wireless router.

### Wired Connections

#### If the wired network connection is lost

- The cable may be loose or damaged.
- Verify that both ends of the network cable are connected. Try another network cable, if available.

## Solving Problems

The link integrity light on the network connector lets you verify that your connection is working and provides information on the status:

- Green — A good connection exists between a 10-Mbps network and the computer.
- Orange — A good connection exists between a 100-Mbps network and the computer.
- Yellow — A good connection exists between a 1000-Mbps network and the computer.
- Off — The computer is not detecting a physical connection to the network.

 **NOTE:** The link integrity light on the network connector provides the status only for wired cable connection. The link integrity light does not provide status for wireless connections.

## Power Problems

**If the power light is off** — The computer is either turned off or is not receiving power.

- Remove the AC adapter and try turning on the computer with the battery.
- Remove the battery and try turning on the computer with the AC adapter.
- Check both ends of the AC adapter cable connections. Ensure that the light on the AC adapter is on. If the light is not on, try plugging the AC adapter into another electrical outlet.

The power/battery lights on the hinges indicate the following:

*On battery power:*

- Solid white – computer is running on battery power
- Solid amber – battery is low
- Flashing amber – battery is critically low
- Blinking white – computer in in sleep state



*On AC adapter:*

- Solid white – computer is powered on and battery is charged
- Blinking white – computer is in a standby state

## Memory Problems

**If you experience memory problems —**

- Check if the memory module is compatible with your computer. Your computer supports DDR3 memory. For more information about the type of memory supported by your computer, see “Basic Specifications” on page 50.
- Run the Dell Diagnostics (see “Dell Diagnostics” on page 36).
- Reseat the memory modules (see the *Service Manual* on the Dell Support website at [support.dell.com](http://support.dell.com)) to ensure that your computer is successfully communicating with the memory.

## Lockups and Software Problems

**If a program stops responding —** End the program:

1. Press <Ctrl><Shift><Esc> simultaneously.
2. Click the **Applications** tab.
3. Select the program that is no longer responding.
4. Click **End Task**.

**If the computer stops responding —**

-  **NOTICE:** You might lose data if you are unable to perform an operating system shutdown.

Turn the computer off. If you are unable to get a response by pressing a key on your keyboard or moving your mouse, press and hold the power button until the computer turns off and then turn your computer on.

## Solving Problems

**If a solid blue screen appears** — Turn the computer off. If you are unable to get a response by pressing a key on your keyboard or moving your pointer or mouse, press and hold the power button until the computer turns off and then turn your computer on.

**If you have other software problems** —

- Keep backup copies of your important data always.
- Use a virus-scanning program to check your computer.
- Save and close any open files or programs and shut down your computer using the **Start**  menu.
- Check the software documentation or contact the software manufacturer for troubleshooting information:
  - Ensure that the program is compatible with the operating system installed on your computer.
  - Ensure that your computer meets the minimum hardware requirements needed to run the software. See the software documentation for information.
  - Ensure that the program is installed and configured properly.
  - Uninstall and then reinstall the program, if necessary.
  - Write down any error message that is displayed to help in troubleshooting.

# Using Support Tools

## Dell Support Center

The Dell Support Center helps you find service, support, and system-specific information that you need. For more information about Dell Support Center and available support tools, click the **Services** tab at **support.dell.com**.



Click the  icon in the taskbar to run the application. The home page provides links to access:

- Self Help (Troubleshooting, Security, System Performance, Network/Internet, Backup/Recovery, and Windows Vista®)
- Alerts (Technical support alerts relevant to your computer)

- Assistance from Dell (Technical Support with DellConnect™, Customer Service, Training and Tutorials, How-To Help with Dell on Call, and Online Scan with PC CheckUp)
- About Your System (System Documentation, Warranty Information, System Information, Upgrades & Accessories)

The top of the Dell Support Center home page displays your computer's model number along with its service tag and express service code.

For more information about the Dell Support Center, see the *Dell Technology Guide* on your hard drive or on the Dell Support website at **support.dell.com**.

### System Messages

If your computer has an issue or error, it may display a System Message that will help you identify the cause and action needed to resolve the issue.

 **NOTE:** If the message you received is not listed in the following examples, see the documentation for either the operating system or the program that was running when the message appeared. Alternatively, you could see the *Service Manual* on the Dell Support website at [support.dell.com](http://support.dell.com) or see “Contacting Dell” on page 47 for assistance.

**Alert! Previous attempts at booting this system have failed at checkpoint [nnnn]. For help in resolving this problem, please note this checkpoint and contact Dell Technical Support** — The computer failed to complete the boot routine some consecutive number of times for the same error, see “Contacting Dell” on page 47 for assistance.

**CMOS checksum error** — Possible system board failure or real-time clock (RTC) battery low. Replace the battery. See the *Service Manual* on the Dell Support website at [support.dell.com](http://support.dell.com) or see “Contacting Dell” on page 47 for assistance.

**CPU fan failure** — CPU fan has failed. Replace the CPU fan. See the *Service Manual* on the Dell Support website at [support.dell.com](http://support.dell.com).

**Hard-disk drive failure** — Possible hard-disk drive (HDD) failure during Power On Self Test (POST), see “Contacting Dell” on page 47 for assistance.

**Hard-disk drive read failure** — Possible hard-disk drive failure during HDD boot test, see “Contacting Dell” on page 47 for assistance.

**Keyboard failure** — Keyboard has failed or the keyboard cable is loose.

**No boot device available** — No bootable partition on hard-disk drive, the hard-disk drive cable is loose, or no bootable device exists.

- If the hard drive is your boot device, ensure that the cables are connected and that the drive is installed properly and partitioned as a boot device.
- Enter system setup and ensure that the boot sequence information is correct or see the *Service Manual* on the Dell Support website at [support.dell.com](http://support.dell.com).

**No timer tick interrupt** — A chip on the system board might be malfunctioning or system board failure. See the *Service Manual* on the Dell Support website at [support.dell.com](http://support.dell.com).

**USB over current error** — Disconnect the USB device. Your USB device needs more power to function properly. Use an external power source to connect the USB device, or if your device has two USB cables, connect both of them.

**NOTICE - Hard Drive SELF MONITORING SYSTEM has reported that a parameter has exceeded its normal operating range. Dell recommends that you back up your data regularly. A parameter out of range may or may**

**not indicate a potential hard drive problem** — S.M.A.R.T (Self-Monitoring Analysis and Reporting Technology) error, possible hard-disk drive failure. This feature can be enabled or disabled in the BIOS setup. See “Contacting Dell” on page 47 for assistance.

## Hardware Troubleshooter

If a device is either not detected during the operating system setup or is detected but incorrectly configured, you can use the **Hardware Troubleshooter** to resolve the incompatibility.

To start the Hardware Troubleshooter:

1. Click **Start**  → **Help and Support**.
2. Type `hardware troubleshooter` in the search field and press <Enter> to start the search.
3. In the search results, select the option that best describes the problem and follow the remaining troubleshooting steps.

### Dell Diagnostics

If you experience a problem with your computer, perform the checks in “Lockups and Software Problems” on page 31 and run the Dell Diagnostics before you contact Dell for technical assistance.

It is recommended that you print this procedure before you begin.

 **NOTE:** Dell Diagnostics works only on Dell computers.

#### Starting Dell Diagnostics

The Dell Diagnostics is located on a hidden diagnostic utility partition on your hard drive.

1. Ensure that the computer is connected to an electrical outlet that is known to be working properly.
2. Hold down the <Fn> key while pressing the power button to turn on the computer.

3. Follow the on-screen instructions.

 **NOTE:** If your computer cannot display a screen image, running the diagnostics will start testing the display. The diagnostics beeps while testing the display. If the display still does not show anything, try connecting an external monitor or contact Dell, see “Contacting Dell” on page 47.

# System Restore Options

You can restore your operating system in the following ways:

- System Restore returns your computer to an earlier operating state without affecting data files. Use System Restore as the first solution for restoring your operating system and preserving data files.
- Dell Factory Image Restore returns your hard drive to the operating state it was in when you purchased the computer. Dell Factory Image Restore permanently deletes all data on the hard drive and removes any programs installed after you received the computer. Use Dell Factory Image Restore only if System Restore did not resolve your operating system problem.

- If you received an Operating System disc with your computer, you can use it to restore your operating system. However, using the Operating System disc also deletes all data on the hard drive. Use the disc only if System Restore did not resolve your operating system problem.

## System Restore

The Windows operating systems provide a System Restore option which allows you to return your computer to an earlier operating state (without affecting data files) if changes to the hardware, software, or other system settings have left the computer in an undesirable operating state. Any changes that System Restore makes to your computer are completely reversible.

## System Restore Options

- ➔ **NOTICE:** Make regular backups of your data files. System Restore does not monitor your data files or recover them.
- ✍ **NOTE:** The procedures in this document were written for the Windows default view, so they may not apply if you set your Dell™ computer to the Windows Classic view.

### Starting System Restore

1. Click **Start** .
2. In the **Start Search** box, type `System Restore` and press <Enter>.
- ✍ **NOTE:** The **User Account Control** window may appear. If you are an administrator on the computer, click **Continue**; otherwise, contact your administrator to continue the desired action.
3. Click **Next** and follow the remaining prompts on the screen.

In the event that System Restore did not resolve the issue, you may undo the last system restore.

### Undoing the Last System Restore

- ✍ **NOTE:** Before you undo the last system restore, save and close all open files and exit any open programs. Do not alter, open, or delete any files or programs until the system restoration is complete.

1. Click **Start** .
2. In the **Start Search** box, type `System Restore` and press <Enter>.
3. Click **Undo my last restoration** and click **Next**.

### Dell Factory Image Restore

- ➔ **NOTICE:** Using Dell Factory Image Restore permanently deletes all data on the hard drive and removes any programs or drivers that you installed after you received your computer. If possible, back up the data before using these options. Use Dell Factory Image Restore only if System Restore did not resolve your operating system problem.



 **NOTE:** Dell Factory Image Restore may not be available in certain countries or on certain computers.

Use Dell Factory Image Restore only as the method of last resort to restore your operating system. This option restores your hard drive to the operating state it was in when you purchased the computer. Any programs or files added since you received your computer—including data files—are permanently deleted from the hard drive. Data files include documents, spreadsheets, e-mail messages, digital photos, music files, and so on. If possible, back up all data before using Dell Factory Image Restore.

### Performing Dell Factory Image Restore

1. Turn on the computer.
2. When the Dell logo appears, press <F8> several times to access the **Vista Advanced Boot Options** window.

3. Select **Repair Your Computer**. The **System Recovery Options** window appears.
4. Select a keyboard layout and click **Next**.
5. To access the recovery options, log on as a local user. To access the command prompt, type `administrator` in the **User name** field, then click **OK**.
6. Click **Dell Factory Image Restore**. The **Dell Factory Image Restore** welcome screen appears.

 **NOTE:** Depending upon your configuration, you may need to select **Dell Factory Tools** → **Dell Factory Image Restore**.

7. Click **Next**. The **Confirm Data Deletion** screen appears.
-  **NOTE:** If you do not want to proceed with Dell Factory Image Restore, click **Cancel**.
8. Click the checkbox that appears to confirm that you want to continue reformatting the hard drive and restore the system software to the factory settings, then click **Next**.

## System Restore Options

The restore process begins and may take five or more minutes to complete. A message appears when the operating system and factory-installed applications have been restored to factory settings.

9. Click **Finish** to reboot the computer.

## Operating System Reinstallation

### Before you Begin

If you are considering reinstalling the Windows operating system to correct a problem with a newly installed driver, first try using Windows Device Driver Rollback. If Device Driver Rollback does not resolve the problem, then use System Restore to return your operating system to the operating state it was in before you installed the new device driver. See “System Restore” on page 37.

 **NOTICE:** Before installing the operating system, back up all data files on your primary hard drive. For conventional hard drive configurations, the primary hard drive is the first drive detected by the computer.

To reinstall Windows, you need the following items:

- Dell *Operating System* media
- Dell *Drivers and Utilities* media

 **NOTE:** The Dell *Drivers and Utilities* media contains drivers that were installed during the assembly of the computer. Use the Dell *Drivers and Utilities* media to load any required drivers. Depending on the region from which you ordered your computer, or whether you requested the media, the Dell *Drivers and Utilities* media and *Operating System* media may not ship with your computer.

## Reinstalling Windows Vista®

The reinstallation process can take one to two hours to complete. After you reinstall the operating system, you must also reinstall the device drivers, virus protection program, and other software.

1. Save and close any open files and exit any open programs.
2. Insert the *Operating System* disc.
3. Click **Exit** if the **Install Windows** message appears.
4. Restart the computer.
5. When the DELL logo appears, press <F12> immediately.

 **NOTE:** If you wait too long and the operating system logo appears, continue to wait until you see the Microsoft® Windows® desktop; then, shut down your computer and try again.

 **NOTE:** The next steps change the boot sequence for one time only. On the next start-up, the computer boots according to the devices specified in the system setup program.

6. When the boot device list appears, highlight **CD/DVD/CD-RW Drive** and press <Enter>.
7. Press any key to Boot from CD-ROM. Follow the instructions on the screen to complete the installation.

# Getting Help

If you experience a problem with your computer, you can complete the following steps to diagnose and troubleshoot the problem:

1. See “Solving Problems” on page 29 for information and procedures that pertain to the problem your computer is experiencing.
2. See “Dell Diagnostics” on page 36 for procedures on how to run Dell Diagnostics.
3. Fill out the “Diagnostic Checklist” on page 46.
4. Use Dell’s extensive suite of online services available at Dell Support ([support.dell.com](http://support.dell.com)) for help with installation and troubleshooting procedures. See “Online Services” on page 43 for a more extensive list of Dell Support online.
5. If the preceding steps have not resolved the problem, see “Contacting Dell” on page 47.

 **NOTE:** Call Dell Support from a telephone near the computer so that the support staff can assist you with any necessary procedures.

 **NOTE:** Dell’s Express Service Code system may not be available in all countries.

When prompted by Dell’s automated telephone system, enter your Express Service Code to route the call directly to the proper support personnel. If you do not have an Express Service Code, open the **Dell Accessories** folder, double-click the **Express Service Code** icon, and follow the directions.

 **NOTE:** Some of the services are not always available in all locations outside the continental U.S. Call your local Dell representative for information on availability.

## Technical Support and Customer Service

Dell's support service is available to answer your questions about Dell hardware. Our support staff uses computer-based diagnostics to provide fast, accurate answers.

To contact Dell's support service, see "Before You Call" on page 46 and then see the contact information for your region or go to **support.dell.com**.

### DellConnect™

DellConnect is a simple online access tool that allows a Dell service and support associate to access your computer through a broadband connection, diagnose your problem and repair it all under your supervision. For more information, go to **support.dell.com** and click **DellConnect**.

## Online Services

You can learn about Dell products and services on the following websites:

- **www.dell.com**
- **www.dell.com/ap** (Asian/Pacific countries only)
- **www.dell.com/jp** (Japan only)
- **www.euro.dell.com** (Europe only)
- **www.dell.com/la** (Latin American and Caribbean countries)
- **www.dell.ca** (Canada only)

You can access Dell Support through the following websites and e-mail addresses:

Dell Support websites

- **support.dell.com**
- **support.jp.dell.com** (Japan only)
- **support.euro.dell.com** (Europe only)

## Getting Help

Dell Support e-mail addresses

- **mobile\_support@us.dell.com**
- **support@us.dell.com**
- **la-techsupport@dell.com** (Latin America and Caribbean countries only)
- **apsupport@dell.com** (Asian/Pacific countries only)

Dell Marketing and Sales e-mail addresses

- **apmarketing@dell.com** (Asian/Pacific countries only)
- **sales\_canada@dell.com** (Canada only)

Anonymous file transfer protocol (FTP)

- **ftp.dell.com**

Log in as user: `anonymous`, and use your e-mail address as your password.

## AutoTech Service

Dell's automated support service—AutoTech—provides recorded answers to the questions

most frequently asked by Dell customers about their laptop and desktop computers.

When you call AutoTech, use your touch-tone telephone to select the subjects that correspond to your questions. For instructions on accessing the telephone number to call for your region, see “Contacting Dell” on page 47.

### Automated Order-Status Service

To check on the status of any Dell products that you have ordered, you can go to **support.dell.com**, or you can call the automated order-status service. A recording prompts you for the information needed to locate and report on your order. For the telephone number to call for your region for problems with your order, see “Contacting Dell” on page 47.

If you have a problem with your order, such as missing parts, wrong parts, or incorrect billing, contact Dell for customer assistance. Have your invoice or packing slip handy when you call. For the telephone number to call for your region, see “Contacting Dell” on page 47.

## Product Information

If you need information about additional products available from Dell, or if you would like to place an order, visit the Dell website at **www.dell.com**. For the telephone number to call for your region or to speak to a sales specialist, see “Contacting Dell” on page 47.

## Returning Items for Repair Under Warranty or for Credit

Prepare all items being returned, whether for repair or credit, as follows:

1. Call Dell to obtain a Return Material Authorization Number, and write it clearly and prominently on the outside of the box.
2. For the telephone number to call for your region, see “Contacting Dell” on page 47.
3. Include a copy of the invoice and a letter describing the reason for the return.
4. Include a copy of the Diagnostics Checklist (see “Diagnostic Checklist” on page 46), indicating the tests that you have run and any error messages reported by the Dell Diagnostics (see “Dell Diagnostics” on page 36).
5. Include any accessories that belong with the item(s) being returned (power cables, software, guides, and so on) if the return is for credit.
6. Pack the equipment to be returned in the original (or equivalent) packing materials.
7. You are responsible for paying shipping expenses. You are also responsible for insuring any product returned, and you assume the risk of loss during shipment to Dell. Collect On Delivery (C.O.D.) packages are not accepted.
8. Returns that are missing any of the preceding requirements will be refused at Dell’s receiving dock and returned to you.

### Before You Call

 **NOTE:** Have your Express Service Code ready when you call. The code helps Dell's automated-support telephone system direct your call more efficiently. You may also be asked for your Service Tag (The Service Tag and Express Service Code are displayed on the Dell Support Centre Welcome page).

Remember to fill out the following Diagnostics Checklist. If possible, turn on your computer before you call Dell for assistance and call from a telephone at or near the computer. You may be asked to type some commands at the keyboard, relay detailed information during operations, or try other troubleshooting steps possible only at the computer itself. Ensure that the computer's documentation is available.

### Diagnostic Checklist

- Name:
- Date:
- Address:
- Phone number:
- Service Tag (barcode on the back or bottom of the computer):
- Express Service Code:
- Return Material Authorization Number (if provided by Dell support technician):
- Operating system and version:
- Devices:
- Expansion cards:
- Are you connected to a network? Yes /No
- Network, version, and network adapter:
- Programs and versions:

See your operating system's documentation to determine the contents of the computer's start-up files. If the computer is connected to



a printer, print each file. Otherwise, record the contents of each file before calling Dell.

- Error message, beep code, or diagnostic code:
- Description of problem and troubleshooting procedures you performed:

## Contacting Dell

For customers in the United States, call 800-WWW-DELL (800-999-3355).

 **NOTE:** If you do not have an active Internet connection, you can find contact information on your purchase invoice, packing slip, bill, or Dell product catalog.

Dell provides several online and telephone-based support and service options. Availability varies by country and product, and some services may not be available in your area.

To contact Dell for sales, technical support, or customer service issues:

1. Visit **support.dell.com**.
2. Verify your country or region in the **Choose A Country/Region** drop-down menu at the bottom of the page.
3. Click **Contact Us** on the left side of the page.
4. Select the appropriate service or support link based on your need.
5. Choose the method of contacting Dell that is convenient for you.

# Finding More Information and Resources

**If you need to:**

---

reinstall your operating system.

---

run a diagnostic program for your computer, reinstall Notebook system software, or update drivers for your computer, and readme files.

---

learn more about your operating system, maintaining peripherals, RAID, Internet, Bluetooth®, networking, and e-mail.

---

upgrade your computer with new or additional memory, or a new hard drive.

---

reinstall or replace a worn or defective part.

**See:**

---

the *Operating System* media.

---

the *Drivers and Utilities* media.



**NOTE:** Drivers and documentation updates can be found on the Dell™ Support website at **support.dell.com**.

---

the *Dell Technology Guide* installed on your hard drive.

---

the *Service Manual* on the Dell Support website at **support.dell.com**



**NOTE:** In some countries, opening and replacing parts of your computer may void your warranty. Check your warranty and return policies before working inside your computer.

---

### If you need to:

---

find your Service Tag/Express Service Code—  
You must use the service tag to identify your  
computer on **support.dell.com** or to contact  
technical support.

---

find drivers and downloads.

access technical support and product help.

check on your order status for new purchases.

find solutions and answers to common  
questions.

locate information for last-minute updates  
about technical changes to your computer or  
advanced technical-reference material for  
technicians or experienced users.

---

### See:

---

the back or bottom of your computer or on the  
Dell Support Center welcome page

---

the Dell Support website at  
**support.dell.com.**

# Basic Specifications

## System Model

---

Studio XPS 1340

This section provides basic information that you may need when setting up, updating drivers for, and upgrading your computer. For more detailed specifications, see the *Service Manual* on the Dell Support website at [support.dell.com](http://support.dell.com).



**NOTE:** Offerings may vary by region.

For more information regarding the configuration of your computer, click

**Start**  → **Help and Support** and select the option to view information about your computer.

## Processor

---

Type	L2 cache
Intel® Core™ 2 Duo	3 MB/6 MB
External bus frequency	1066 MHz

## ExpressCard

---

ExpressCard controller	GeForce 9400M G
ExpressCard connector	one ExpressCard slot (54 mm)
Cards supported	ExpressCard/34 (34 mm) ExpressCard/54 (54 mm) 1.5 V and 3.3 V
ExpressCard connector size	26 pins

**Memory**

---

Connectors	two internally-accessible SO-DIMM sockets
Capacities	512 MB, 1 GB, and 2 GB
Memory type	1066 MHz DDR3 SO-DIMM
Memory configuration possible	1 GB, 1.5 GB, 2 GB, 3 GB, and 4 GB

 **NOTE:** For instructions on upgrading your memory, see the *Service Manual* on the Dell Support website at [support.dell.com](http://support.dell.com).

**Computer Information**

---

System Chipset	GeForce 9400M G
Data bus width	64 bits
DRAM bus width	dual channel (2) 64-bit buses
Processor address bus width	32 bits
Flash EPROM	16 Mbit
Graphics bus	PCI-E X16
PCI Bus	32 bits

**Communications**

---

Modem type	External V.92 56 K USB Modem
Modem controller	Hardware Modem
Modem interface	Universal Serial Bus (USB)

## Basic Specifications

### Communications

---

Network adapter	10/100/1000 Ethernet LAN on system board
Wireless	internal WLAN (half-size Mini-Card), WWAN, Mini-Card with Bluetooth® wireless technology, UWB Mini-Cards WWAN ExpressCard Bluetooth® wireless technology

### Video

---

#### *Discrete*

Video type	integrated on system board
Video controller	GeForce 9500M (GeForce 9400M G + GeForce 9200M GS)

### Video

---

Video memory	256 MB dedicated memory
<i>UMA</i>	
Video type	integrated on system board
video controller	GeForce 9400M G
video memory	based on system memory
LCD interface	LVDS
Display support	VGA, HDMI, and DisplayPort

### Audio

---

Audio type	5.1 channel High Definition Audio
Audio controller	IDT 92HD73C HDA Codec

**Audio**

Stereo conversion	24-bit (analog-to-digital and digital-to-analog)
Internal Interface	High Definition Audio
External Interface	dual function microphone-in connector, two stereo headphones/speakers connectors
Speaker	two 4-ohm speakers
Internal speaker amplifier	2 watt per channel
Volume controls	program menus, media control buttons

**Ports and Connectors**

IEEE 1394a	4-pin serial connector
Mini-Card	two Type IIIA Mini-Card slots, one half-size Mini -Card slot
Network adapter	RJ-45 port 10/100/1000
USB	one 4-pin USB 2.0-compliant connector
eSATA	one 4-pin eSATA/USB combo connector
Video	15-hole connector
HDMI	19-pin connector
DisplayPort	20-pin connector

## Basic Specifications

### Display

---

Type (AntiGlare)	13.3-inch WXGA WLED 13.3-inch WXGA CCFL
<i>Dimensions:</i>	
Height	286.08 mm (11.26 in)
Width	178.8 mm (7.03 in)
Diagonal	337.8 mm (13.29 in)
Maximum resolution	1280 x 800
Refresh rate	60 Hz
Operating angle	0° (closed) to 140°
Luminance	225 min. 270 typ. cd/m <sup>2</sup> (LED 5 point avg) 180 min. 198 typ. cd/m <sup>2</sup> (CCFL 5 point avg)

### Display

---

#### *Viewing Angles:*

Horizontal	±40° (CCFL) min. ±50° (LED) min.
Vertical	+15°/–30° (CCFL) min. +40°/–50° (LED) min.
Pixel pitch	0.2235 mm
Controls	brightness can be controlled through keyboard shortcuts (see the <i>Dell Technology Guide</i> for more information)

### Keyboard (Backlit)

---

Number of keys	86/103 (U.S. and Canada); 87/104 (Europe); 90/107 (Japan)
Layout	QWERTY/AZERTY/Kanji



**Camera**

Pixel	1.3/2.0 megapixel
Video resolution	320x240 ~1600x1200 (640x480 at 30 fps)
Diagonal viewing angle	66°

**Touch Pad**

X/Y position resolution (graphics table mode)	240 cpi
<i>Size:</i>	
Width	61.9 mm (2.43 in) sensor-active area
Height	39.04 mm (1.53 in) rectangle

**Battery**

Type	6-cell/9-cell "smart" lithium ion
Depth	50.39 mm (1.98 inches) (6/9 cell)
Height	26.3 mm (0.8 in) (6 cell) 41.9 mm (1.6 in) (9 cell)
Width	204.9 mm (8.03 in) (6 cell) 259.3 mm (10.2 in) (9 cell)
Weight	0.33 kg (0.7 lb) (6 cell) 0.48 kg (1.06 lb) (9 cell)
Voltage	11.1 VDC
Charge time when the computer is off (approximate)	4 hours

## Basic Specifications

### Battery

---

Operating time    battery operating time varies depending on operating conditions and can be significantly reduced under certain power-intensive conditions (see the *Dell Technology Guide* for more information)

Life span (approximate)    300 discharge/charge cycles

#### *Temperature range:*

Operating    0° to 35°C (32° to 95°F)

Storage    -40° to 65°C (-40° to 149°F)

Coin-cell battery    CR-2032

### AC Adapter

---

Input voltage    100–240 VAC

Input current (maximum)    1.5 A

Input frequency    50–60 Hz

Output power    65 W or 90 W

Output current (90 W)    5.62 A (peak for 4-second pulse)  
4.62 A (continuous)

Output current (65 W)    4.34 A (peak for 4-second pulse)  
3.34 A (continuous)

Rated output voltage    19.5 VDC

#### *Dimensions:*

#### *65 W (E-Series)*

Height    16 mm (0.62 in)

**AC Adapter**

---

Width	64 mm (2.51 in)
Depth	127.0 mm (5.0 in)
Weight (without cables)	0.29 kg (0.64 lb)
<i>90 W (E-Series)</i>	

Height	16 mm (0.62 in)
Width	70 mm (2.75 in)
Depth	147 mm (5.7 in)
Weight (without cables)	0.345 kg (0.76 lb)

**AC Adapter**

---

Temperature ranges:	
Operating	0° to 35°C (32° to 95°F)
Storage	-40° to 65°C (-40° to 149°F)

**Physical**

---

Height	22.5 mm to 37.2 mm (0.88 in to 1.46 in)
Width	319.3 mm (12.57 in)
Depth	236.15 mm (9.29 in)
Weight (with 6-cell battery):	
Configurable to less than	2.2 kg (4.9 lb)

## Basic Specifications

### Computer Environment

---

#### *Temperature range:*

Operating	0° to 35°C (32° to 95°F)
Storage	−40° to 65°C (−40° to 149°F)

#### *Relative humidity (maximum):*

Operating	10% to 90% (noncondensing)
Storage	5% to 95% (noncondensing)

#### Maximum vibration (using a random-vibration spectrum that simulates user environment):

Operating	0.66 GRMS
Storage	1.3 GRMS

### Computer Environment

---

Maximum shock (measured with hard drive in head-parked position and a 2-ms half-sine pulse):

Operating	110 G
Storage	163 G

#### *Altitude (maximum):*

Operating	−15.2 to 3048 m (−50 to 10,000 ft)
Storage	−15.2 to 10,668 m (−50 to 35,000 ft)
Airborne contaminant level	G2 or lower as defined by ISA-S71.04-1985

# Index

## A

airflow, allowing **5**

AutoTech **44**

## B

backups

    creating **28**

## C

calling Dell **46**

CDs, playing and creating **27**

chipset **51**

computer capabilities **26**

computer, setting up **5**

computer stand **5**

connect(ing)

    to the Internet **10**

conserving energy **27**

contacting Dell online **47**

customer service **43**

customizing

    your desktop **27**

    your energy settings **27**

## D

damage, avoiding **5**

data, backing up **28**

DellConnect **43**

Dell Diagnostics **36**

Dell Factory Image Restore **37**

Dell Support Center **33**

Dell support website **49**

## Index

Dell Technology Guide

for further information **48**

Device Status Lights **14**

Diagnostic Checklist **46**

disc drive

supported disc sizes **19**

discs

ejecting **19**

using **19**

drivers and downloads **49**

DVDs, playing and creating **27**

## E

email addresses

for technical support **44**

energy

conserving **27**

expansion bus **51**

## F

finding more information **48**

FTP login, anonymous **44**

## H

hardware problems

diagnosing **35**

Hardware Troubleshooter **35**

horizontal and vertical stand options **5**

## I

installing the stand **5**

internet connection **10**

ISP

Internet Service Provider **10**

## M

memory support **50, 51**

**N**

network connection

fixing **29**

**O**

order status **44**

**P**

power adapter

size and weight **56, 57**

power problems, solving **30**

power strips, using **6**

processor **50**

products

information and purchasing **45**

**R**

reinstalling Windows **37**

resources, finding more **48**

restoring factory image **38**

**S**

setup, before you begin **5**

shipping products

for return or repair **45**

software features **26**

specifications **50**

support email addresses **44**

support sites

worldwide **43**

system messages **34**

system restore **37**

**T**

technical support **43**

**V**

ventilation, ensuring **5**

## Index

### W

warranty returns **45**

Windows, reinstalling **37**

Windows Vista® **10**

    reinstalling **41**

    setup **10**

wired network

    network cable, connecting **8**

wireless network connection **29**







Printed in the U.S.A.

[www.dell.com](http://www.dell.com) | [support.dell.com](http://support.dell.com)



OP464CA02



Printed in Malaysia.

[www.dell.com](http://www.dell.com) | [support.dell.com](http://support.dell.com)



OP464CA02



Printed in China.

Printed on recycled paper.

[www.dell.com](http://www.dell.com) | [support.dell.com](http://support.dell.com)



OP464CA02



Printed in Ireland.

[www.dell.com](http://www.dell.com) | [support.dell.com](http://support.dell.com)



OP464CA02





Printed in Brazil.

[www.dell.com](http://www.dell.com) | [support.dell.com](http://support.dell.com)



OP464CA02